

SUBMERSIBLE ELECTRIC PUMPS FOR FOUL WASTE WATER

in AISI 304



Submersible electric pumps for foul waste water in AISI 304 stainless steel.

APPLICATIONS

- Moving foul waste liquids containing solid substances and/or suspended filamentary substances
- Emptying seepage water
- Moving foul waste waters (sanitary services)
- Emptying cesspits and draining into sewers

TECHNICAL DETAILS

- Equipped with 5 m of H07 RN-F power supply cable (on request 10 m of H07 RN-F cable)
- Available with or without float

TECHNICAL DATA

- Maximum immersion: 10 m
- Maximum temperature of the liquid: 50°C
- Max. solids size for passage: 35 mm
- Self-ventilated 2 pole asynchronous motor
- Class of insulation F
- IPX8 Protection rating
- 230V ± 10%, 50Hz single phase voltage
- 400V ± 10%, 50Hz three phase voltage
- Permanent capacitor inserted and thermo-amperometric protection with automatic rearm incorporated for the single phase motor
- Protection under user's responsibility for the three phase version
- Discharge connection: G1½

MATERIALS

- body, impeller, motor cover, seal housing disc and motor case in AISI 304
- Shaft in AISI 303 (part in contact with the liquid)
- Twin mechanical seal with oil chamber:
 - upper in Carbon/Ceramic/NBR (motor side)
 - lower in SiC/SiC/NBR (pump side)

SPECIAL VERSIONS

- MA version with float
- Version with 10 m of cable

For accessories and control panels see from page 142

PERFORMANCE CURVES (according to ISO 9906 Attachment A)

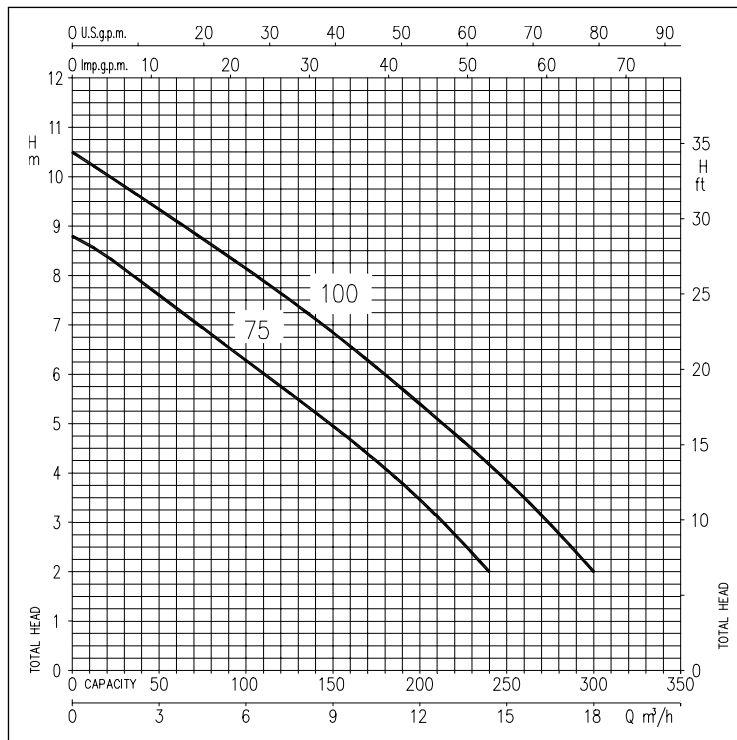

IDENTIFICATION CODE

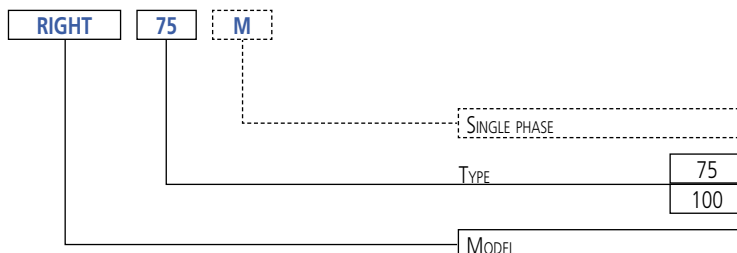

SUBMERSIBLE ELECTRIC PUMPS FOR FOUL WASTE WATER

in AISI 304

PERFORMANCE TABLE

Model		P ₂		Capacitor		Absorbed Curr. [A]		Q=Flow rate							
Single phase 230V	Three phase 230/400V	[HP]	[kW]	μF	Vc	1~	3~	l/min	40	80	120	160	200	240	300
								m ³ /h	2	4,8	7,2	9,6	12	14,4	18
								H=Head [m]							
RIGHT 75 M	RIGHT 75	0,75	0,55	20	450	4,8	2,1	7,8	6,8	5,7	4,7	3,4	2,0	-	-
RIGHT 100 M	RIGHT 100	1	0,75	31,5	450	5,7	2,6	9,5	8,6	7,6	6,6	5,4	4,2	2,0	2,0

DIMENSIONS

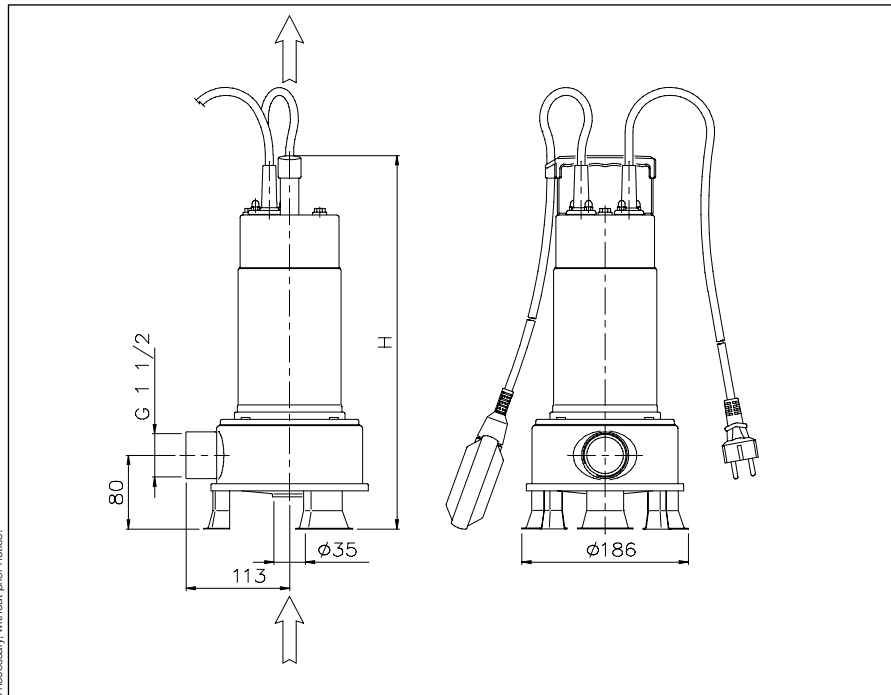

DIMENSIONS TABLE

Model	Dimensions [mm]		Weight [kg]
	H	H2	
RIGHT 75	405	410	10,0
RIGHT 100	430	430	11,5

INSTALLATION

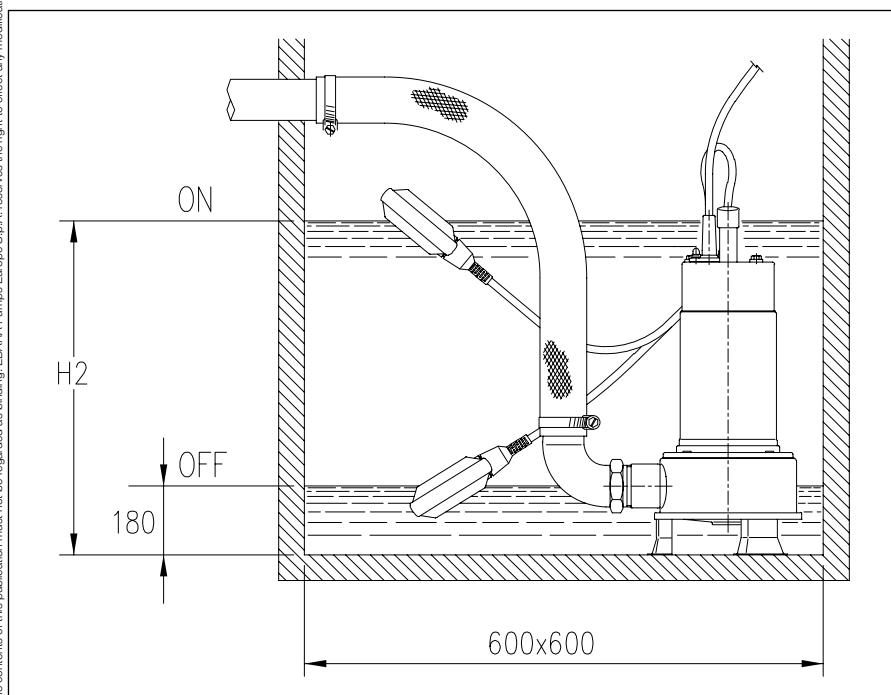

The contents of this publication must not be regarded as binding. EBARA Pumps Europe S.p.A. reserves the right to effect any modification it deems necessary, without prior notice.

SUBMERSIBLE ELECTRIC PUMPS FOR FOUL WASTE WATER in AISI 304

SECTIONAL VIEW

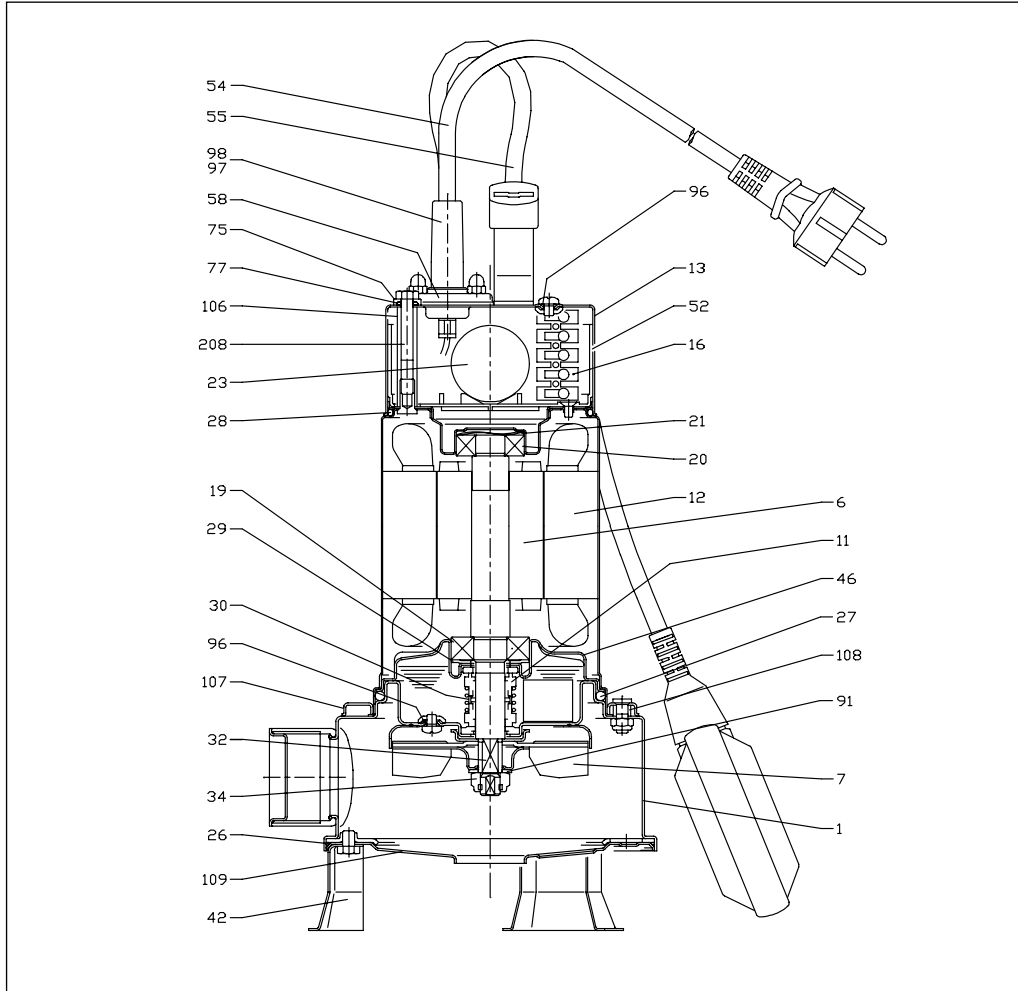

DIMENSIONS TABLE

Ref.	Name	Material	Ref.	Name	Material
1	Pump body	AISI 304	42	Feet	AISI 304
6	Shaft with rotor	AISI 303	46	Lower bearing supp.	AISI 304
7	Impeller	AISI 304	52	Capacitor box	PA66 reinforced with fibreglass
11	Mechanical seal	Ceramic/Carbon/NBR	54	Cable	-
12	Motor case	-	55	Float	-
13	Cover	AISI 304	58	Cable stay	AISI 304
16	Box	-	75	Washer	AISI 303
19	Lower bearing	-	77	O-Ring	NBR
20	Upper bearing	-	91	Washer	AISI 304
21	Adjusting ring	AISI 304	96	O-Ring	NBR
23	Capacitor	-	97	Cable gland	NBR
26	O-Ring	NBR	98	Cable gland	NBR
27	O-Ring	NBR	106	Spacer	AISI 304
28	O-Ring	NBR	107	Fixing flanges	AISI 304
29	Washer	AISI 304	108	Gasket	NBR
30	Spacer for mechanical seal	Brass	109	Suction side lid	AISI 304
32	Key	AISI 304	208	Screw	AISI 304
34	Nut	AISI 303	-	-	-